

Landquist & Son, Inc

PH: 847-674-6600  
 FAX: 847-674-6674  
 BIPASS HARDWARE



DATE: \_\_\_\_\_

**TRACK SIZES IN INCHES:**

QTY	@	LENGTH	QTY	@	LENGTH
_____	@	_____	_____	@	_____
_____	@	_____	_____	@	_____
_____	@	_____	_____	@	_____
_____	@	_____	_____	@	_____

QTY REQ'D	INVOICE CODE	PART NUM		LIST PRICE	EXTENDED SELL PRICE
_____	POBJ	2200	ALUMINUM BIPASS DOOR TRACK	\$4.00 /FT.	_____
_____	UGBX	116	BIPASS DOOR FLOOR GUIDE ( STEEL)	\$5.00 EA.	_____
_____	PVBX	2004	BIPASS DOOR STOP	\$3.00 EA.	_____
_____	PWBX	2165	BIPASS TRACK STOP	\$2.50 EA.	_____
_____	POBX	2226	BIPASS DOOR HANGER ( 1/16" BACK DOOR )	\$4.00 EA.	_____
_____	PPBX	2228	BIPASS DOOR HANGER ( 3/8" FRONT DOOR )	\$4.00 EA.	_____
_____	PSBZ	125-619	BIPASS FLUSH PULL ( SATIN NICKEL )	\$2.50 EA.	_____

**TOTAL PRICE FOR THE HARDWARE**  
**SHIPPING AND HANDLING**  
**TAX %**

**TOTAL PRICE FOR YOUR ORDER**

customer: \_\_\_\_\_

attn: \_\_\_\_\_

address: \_\_\_\_\_

city, state: \_\_\_\_\_

phone # \_\_\_\_\_

email \_\_\_\_\_

P.O. # \_\_\_\_\_

Ship To: \_\_\_\_\_

**\*FOR OFFICE USE ONLY**

OUR ORDER#	H #	CUSTOMER P.O.	SALESMAN	PART TYPE	PLANT CODE	ORDERED BY

# MAGIGLIDE bypass closets using Johnson hardware

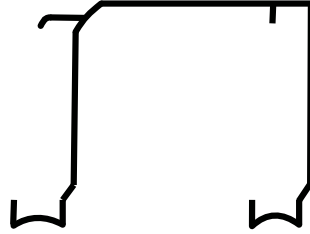
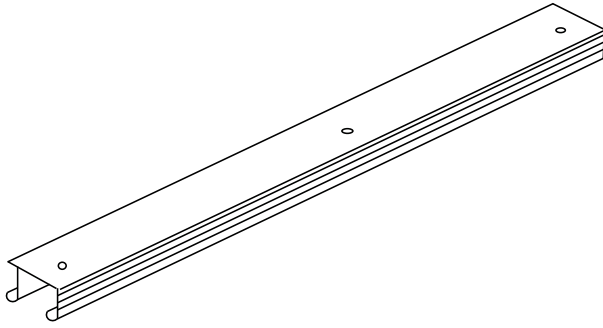

# 2200 ALUMINUM TRACK

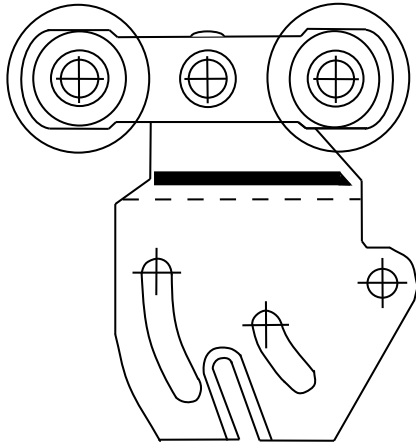

# 2228 HANGER

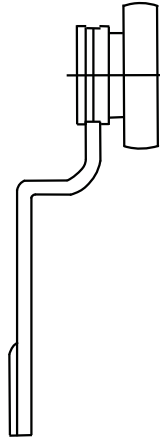

# 2226 HANGER

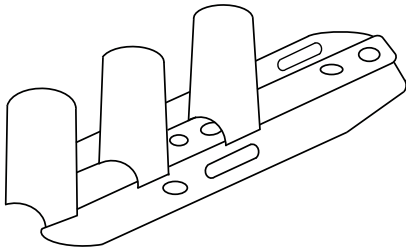
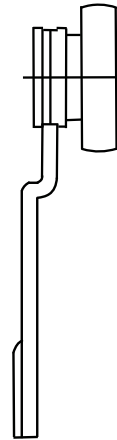

# 116 DOUBLE FLOOR GUIDE

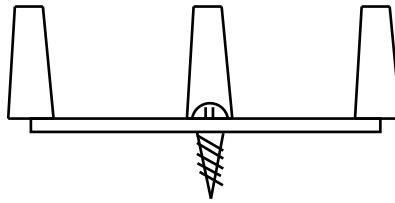

# 2004 DOOR STOP

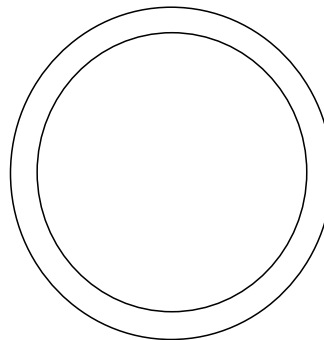
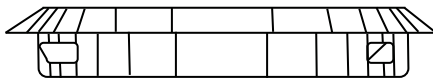
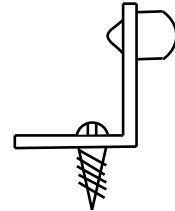

#125 FLUSH PULL

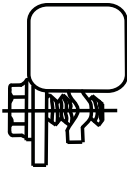
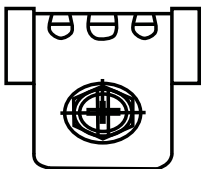

# 2165 TRACK STOP

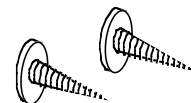

TEK SCREWS